

PIP-BMW 3,5,6,7 series 09

Installation Manual

(BMW 3,5,6,7 series 2009 Round Connector type)

9

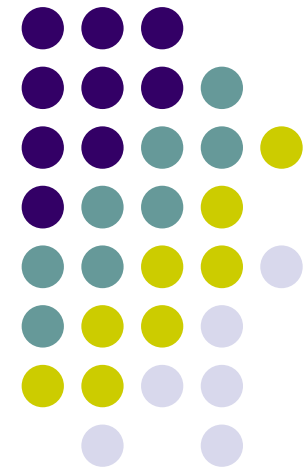

INDEX



- . **PIP BMW 09 Feature**
- . **Precaution**
- . **Main Spec**
- . **System composition diagram**
- . **Dimension**
- . **External Appearance**
- . **Connector Pin Assignment**
- . **DIP SW Setting**
- . **How to use remote**
- . **How to use keypad**
- . **Original buttons**
- . **OSD(On Screen Display**
- . **Rear parking guide line**
- . **Product Composition**
- . **Installation Diagram**
- . **Installation Manual**
- . **Installation Q & A**

-PIP BMW 09 Feature



-Clear quality view

-NTSC, PAL Auto detection

-AV source switching thru genuine button in vehicle.

-Convenient use by remote & keypad

-SAFETY function

***Safety function (Safe mode)**

When this function is operated, the screen does not display any AV source's image.
User can control this function by UP button of Remote or OSD keypad

-Precaution



- Ignition key should be taken off before starting installation, interface power connection must be the last step in installation.
- Power cable should be separated when connecting interface.
- Should be no any electronic devices or magnetic pole around installation place.
- All steps of installation should be done by well-trained specialist.
- Dismantling without manufacturer's permission can not be guaranteed, (No permission to break attached label on the board.)
- Kindly check all parts are in the box, when receiving the product, if anything missing, inform to the supplier or manufacturer.
- According to our sales policy, any problems caused by user's mistake, careless can not be guaranteed.

-Main Spec.



1. Input Spec. (MULTI VIDEO INTERFACE)

- 3 x A/V Input (External video source).
- 1 x CVBS(REAR CAMERA) Input. (Rear camera source)
- 1 x Analog RGB Input (Navigation System output)
- 1 x LCD Input (Car system Input)

2. Output Spec.

- 1 x LCD Output

3. Power Spec.

- Input Power : 8VDC ~ 24VDC
- Consumption Power : 12WATT, Max

4. Switch Input mode

- Input Video MUTE Function : Possible to make each input mute by operating Dip S/W.
- Possible to switch Input mode with Keypad(or Remote control)
- Possible to switch AV3(Front camera) with switch for source toggle
- Detecting rear camera by CAN or rear-lamp wire

-System Composition Diagram

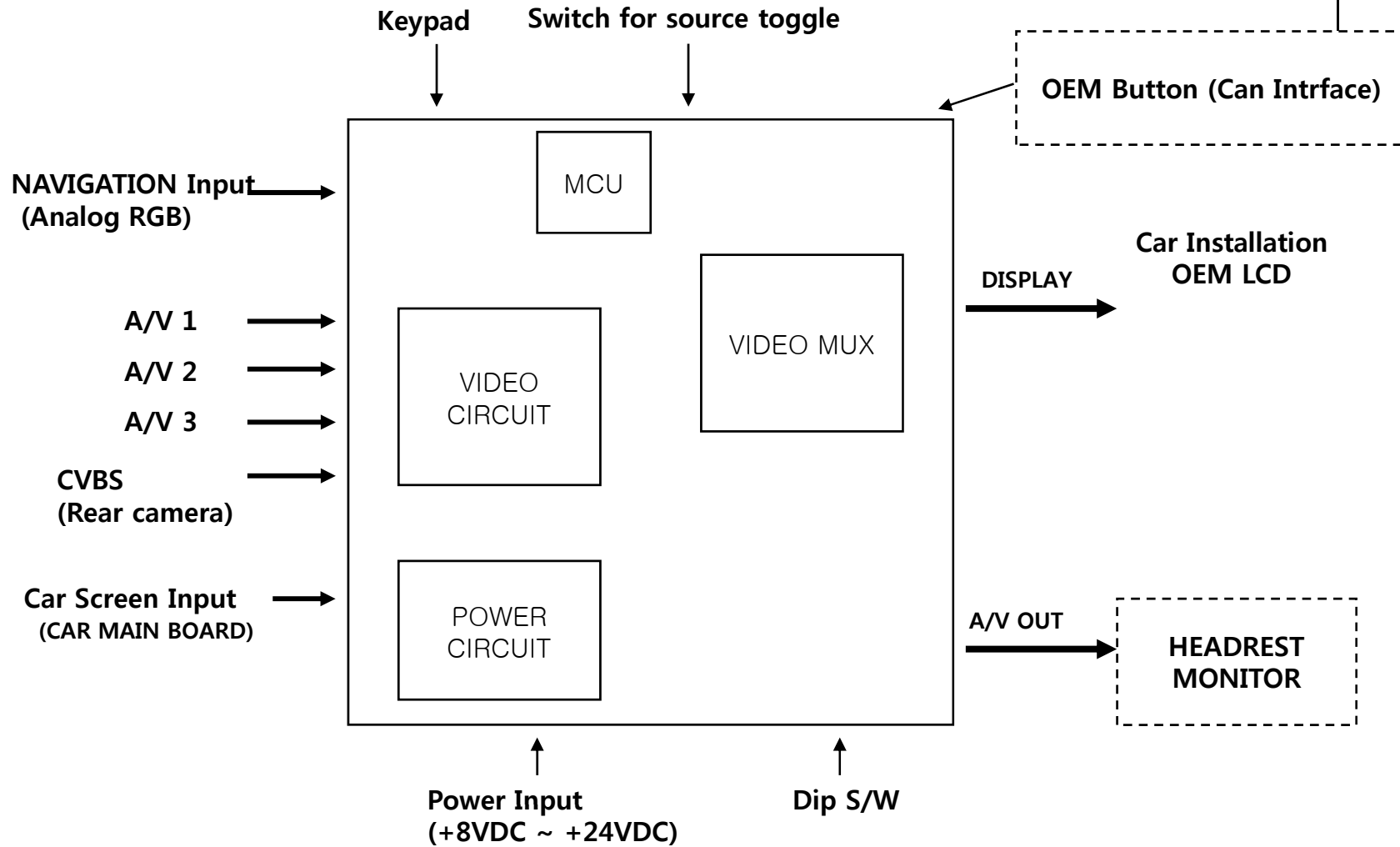

-Dimension

155mm * 93mm * 22mm



-External Appearance

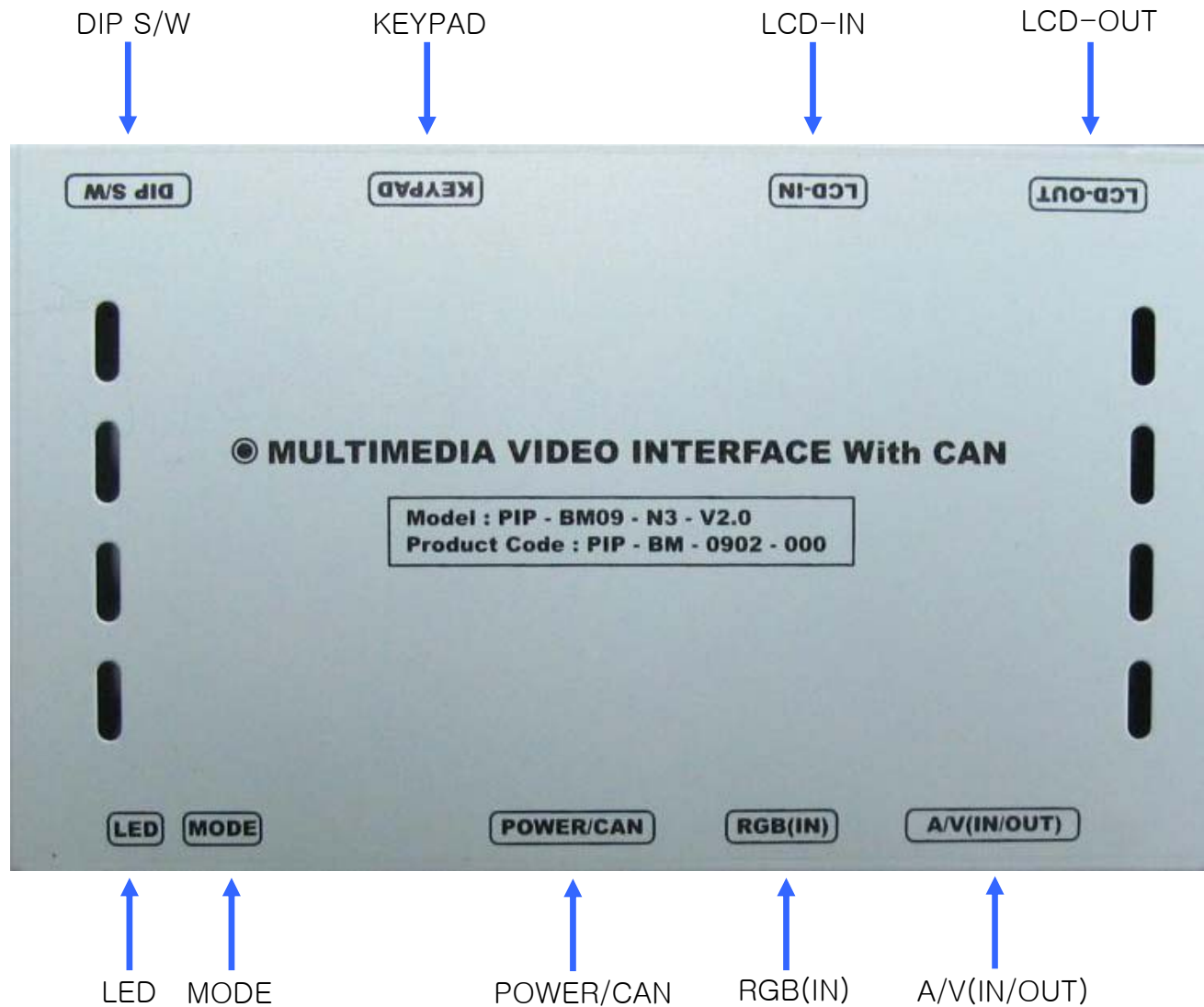

-External Appearance



↑
MODE

↑
POWER/CAN

↑
RGB(IN)

↑
A/V(IN/OUT)



↑
LCD-OUT

↑
LCD-IN

↑
KEYPAD

↑
DIP S/W

-Connector Pin Assignment

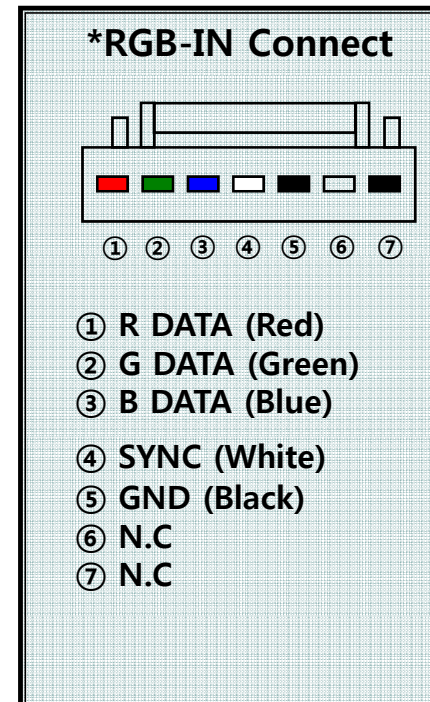
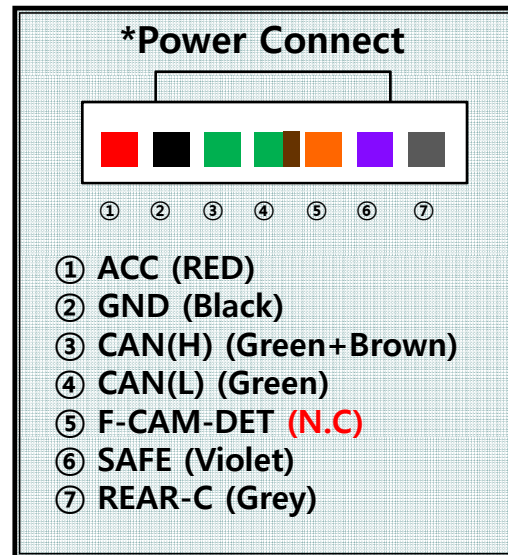

-Connector Pin Assignment



* Power Cable

FILTER
& FUSE BOX

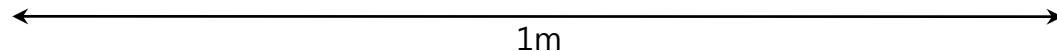
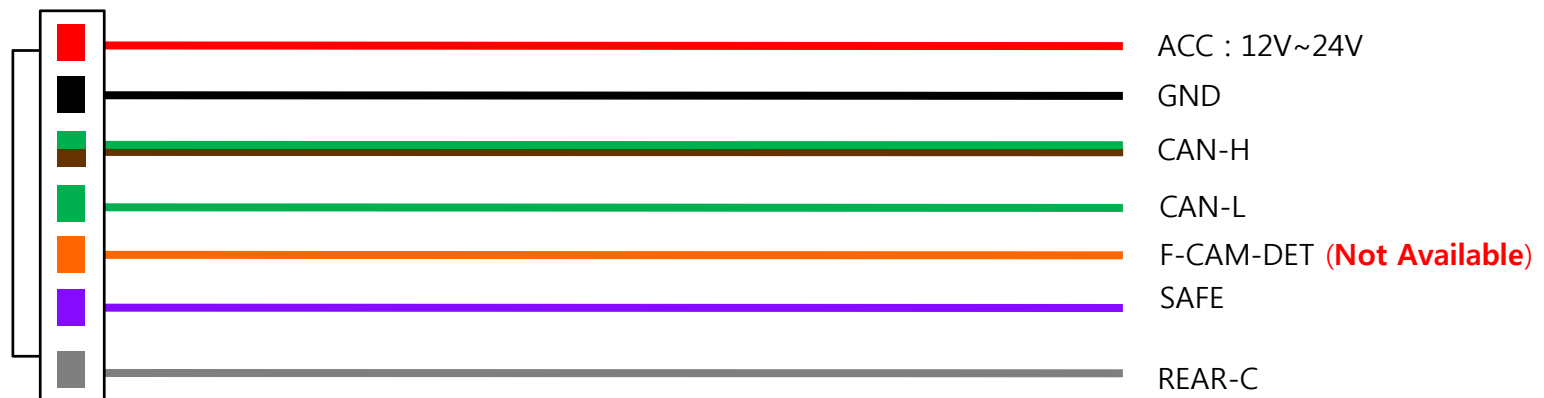
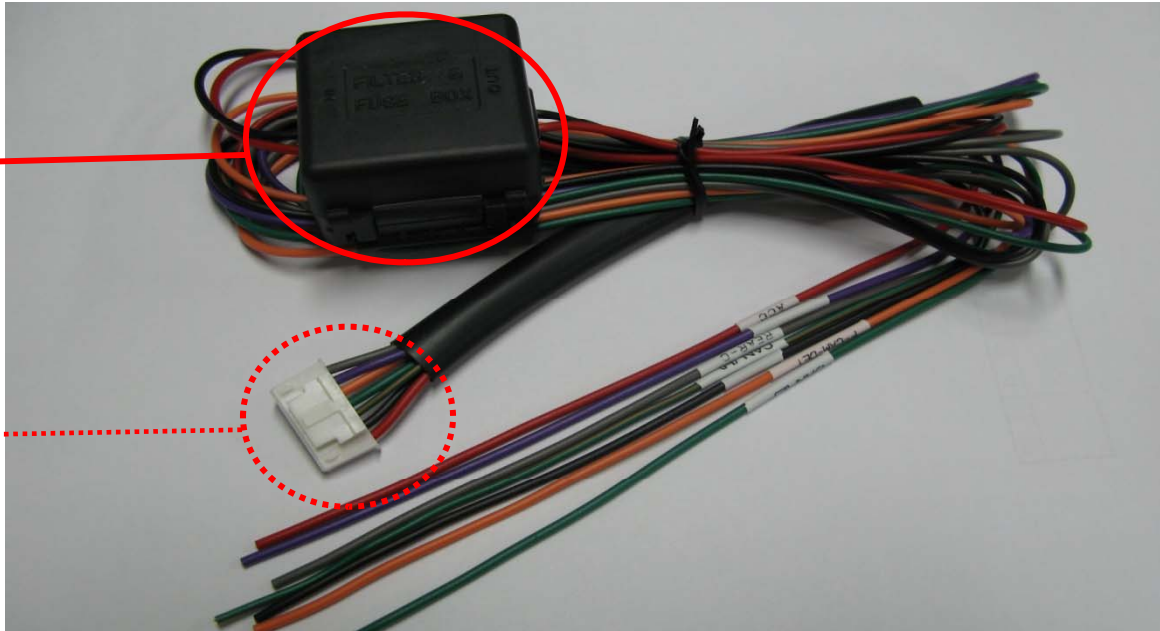

1m

*SAFE : When connecting to GND, switched to MAIN image and initialized.

-DIP SW



※ ON : DOWN, OFF : UP ; Default : all OFF

#PIN	FUNCTION	DIP S/W Selection
1	RGB INPUT MUTE	ON : Skipping RGB Mode OFF : RGB Display
2	A/V 1 MUTE	ON : Skipping A/V 1 OFF : A/V1 Display
3	A/V 2 MUTE	ON : Skipping A/V 2 OFF : A/V2 Display
4	A/V 3 MUTE	ON : Skipping A/V 3 OFF : A/V3 Display
5		N.C
6		N.C
7	When to choose rear mode (ON : CVBS4, OFF : MAIN)	
8		N.C

※DIP S/W Use Example

- . Use Input Mode : A/V2, A/V3
- . Use original Navigation
- . Use rear camera

- ▷ DIP S/W : 1,2 -> ON (INPUT MODE SKIP)
- ▷ DIP S/W : 3 -> OFF (enable A/V3)
- ▷ DIP S/W : 4 -> OFF (enable A/V3)
- ▷ DIP S/W : 5,6 -> OFF
- ▷ DIP S/W : 7 -> ON
- ▷ DIP S/W : 8 -> OFF



-How to use remote



Dimension : 85 * 40 * 8 (mm) – Remote or Keypad (**Optional**)

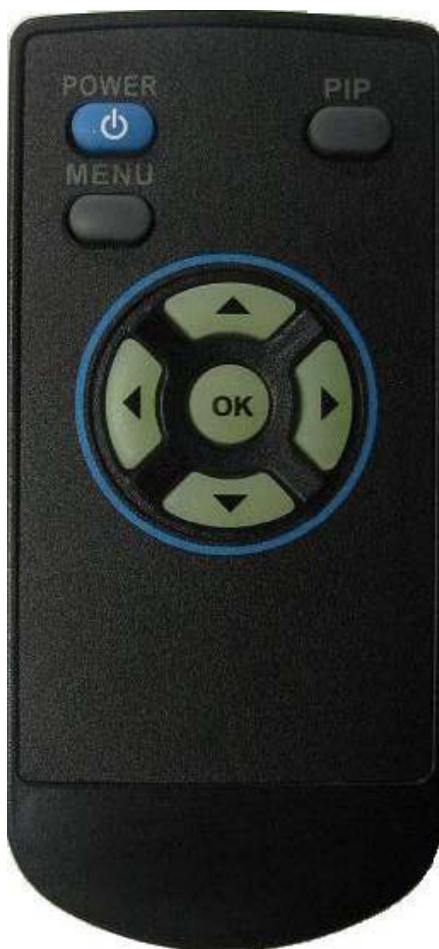

POWER&PIP : N.C

MENU : OSD MENU

OK : Selection

▲ : Up , pressing for 5sec : SAFE MODE Operation.

▼ : Down

◀ : Left

▶ : Right

*FACTORY MODE (Interface setting for **installer**)

: Operated by pressing ▲ → ▼ → ▲ →MENU of remote or keypad in order.

-How to use Keypad



※ Remote or Keypad (Optional)



MENU : OSD Menu, switching to previous mode.

SEL : Selection in menu, switching AV sources.

UP : Move to Left, Up

DOWN : Move to Right, Down

UP + DOWN at once : Operating "SAFE MODE"

*FACTORY MODE (Interface setting for **installer**)

: Operated by pressing ▲ → ▼ → ▲ →MENU of remote or keypad in order.

-Original buttons (E60)



- I-Drive Button



"MENU button" : Long press – Mode switching
Short press – Switching to OEM mode

- Steering wheel buttons



button : Long press – Dual screen operation



button : Long press - Mode Switching

-Original buttons (F01, F02)



- I-Drive Button



MENU Button : Long press – Mode switching
Short press – Back to OEM image

▽ Button : Long press – PIP function Operation

※ In Reverse gear – This function is only available in cars with aftermarket rear camera.

▽ Button : Long press – PIP function Operation
Short press – Positioning Translucent PDC Image

-OSD(On Screen Display)



- Analog RGB Mode

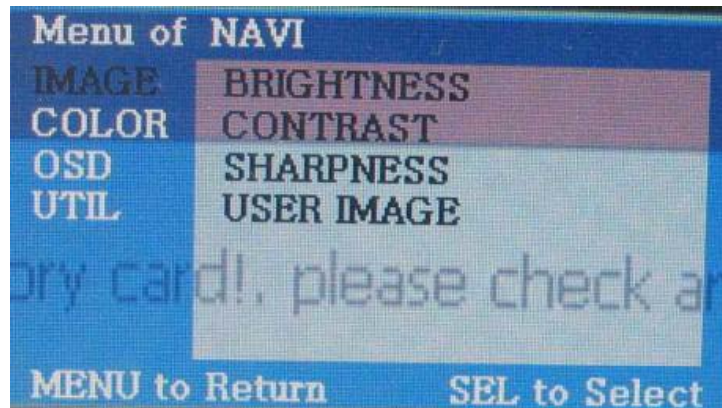

- Video Mode



IMAGE Menu :

- BRIGHTNESS
- CONTRAST
- SATURATION
- HUE
- SHARPNESS
- USER IMAGE

OSD(On Screen Display)



- Analog RGB Mode
- Video Mode

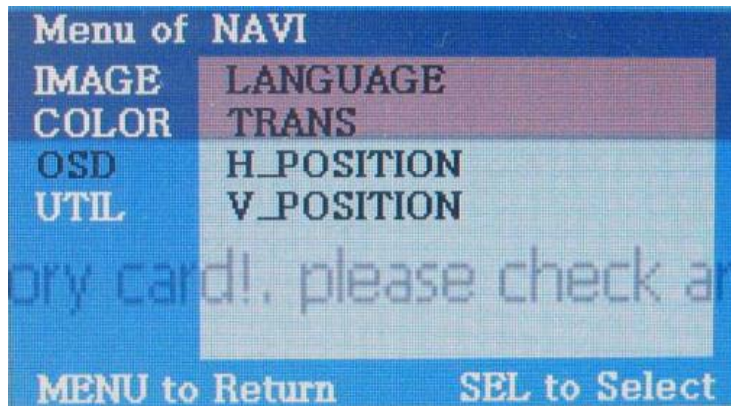

OSD Menu

- LANGUAGE
- OSD TRANS
- OSD H_POS
- OSD V_POS

OSD(On Screen Display)



- Analog RGB Mode
- Video Mode

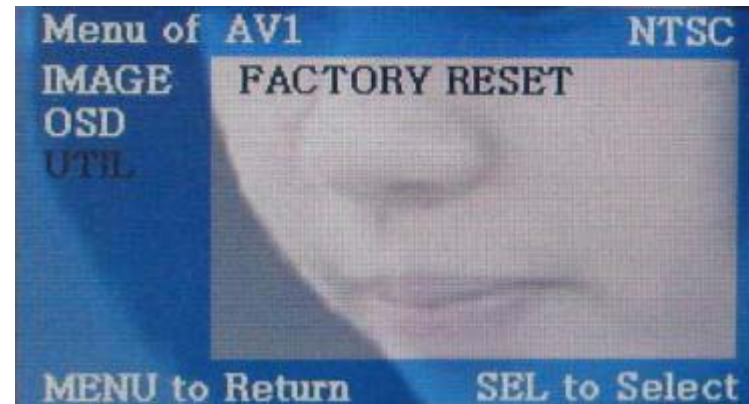
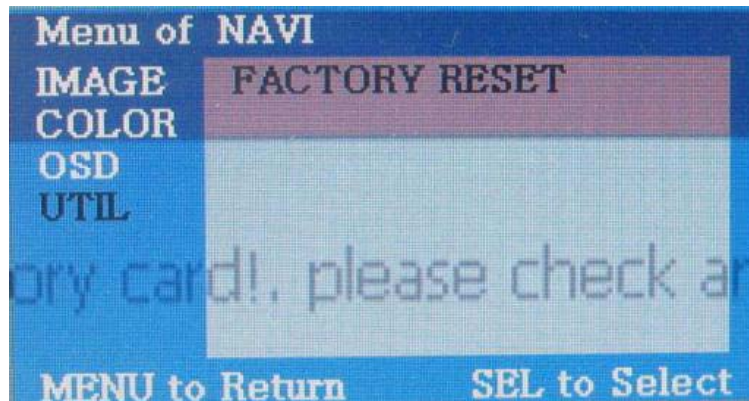

UTIL Menu

- **FACTORY RESET** : Initializing setting value (NAVI, AV individual initialization)

OSD(On Screen Display)



- **Factory Mode**

–Operated by pressing ▲ → ▼ → ▲ →MENU of remote or keypad in order.

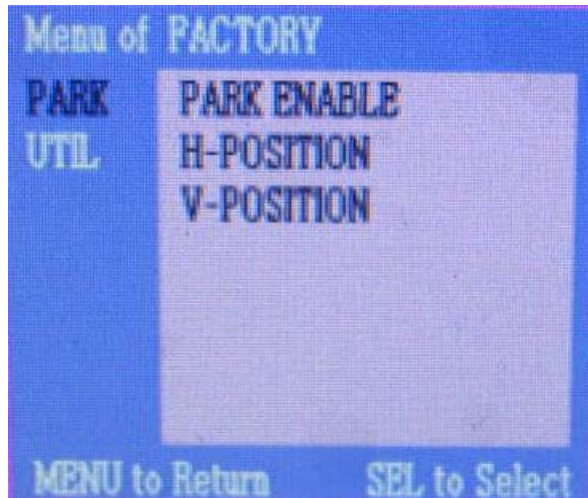

Factory Mode

- **IMAGE :**

- H-POSITION : Move to left and right
- V-POSITION : Move to up and down

- **PARK :** Refer to the next page for detail.

OSD(On Screen Display)



- Factory Mode

-Operated by pressing ▲ → ▼ → ▲ →MENU of remote or keypad in order.

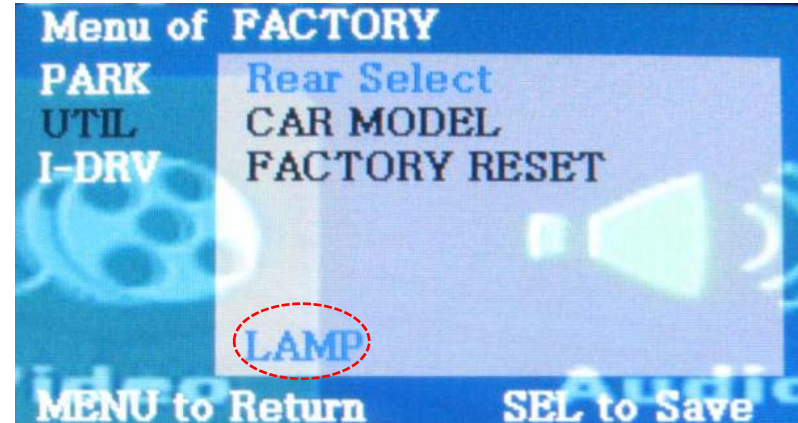

Factory Mode

- UTIL :

- Rear Selection : Rear Camera Detection Method Selection

- LAMP : Detecting Rear Cam by rear lamp in vehicle ('Rear-C' wire of Power cable should be connected with rear lamp in vehicle)

- CAN : Detecting Rear Cam by CAN Signal ('CAN' wires of power should be connected with CAN wires in vehicle)

- FACTORY RESET : Initialization

OSD(On Screen Display)



- Factory Mode

- Operated by pressing ▲ → ▼ → ▲ → MENU of remote or keypad in order.

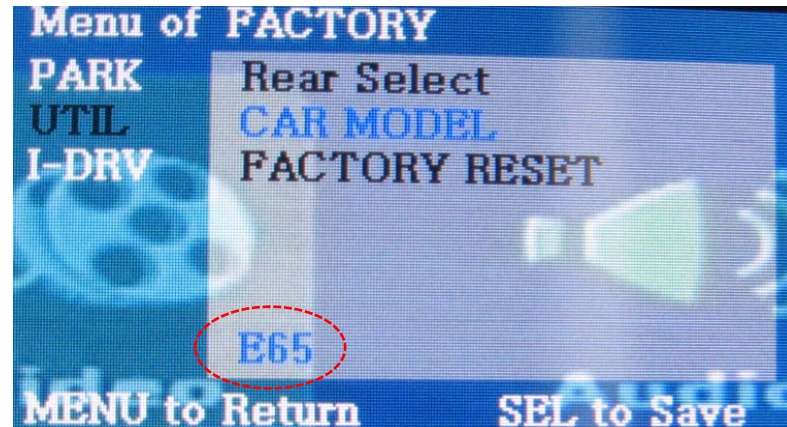
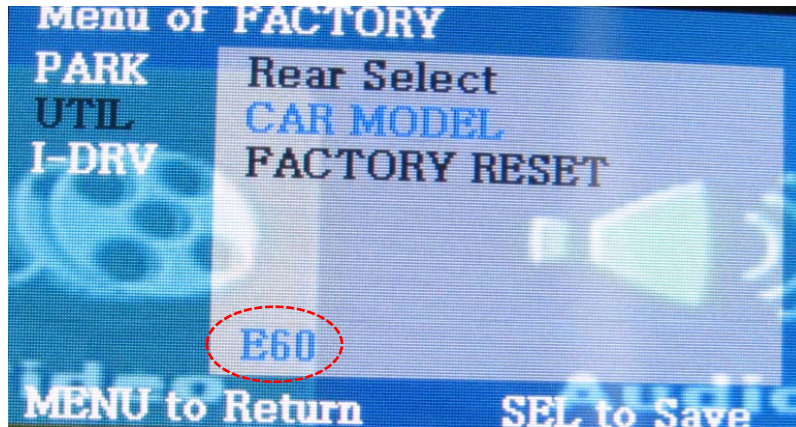

Factory Mode :

- UTIL – CAR MODEL : Select one of 2 models
 - : E60 – For 3, 5 series.
 - : E65 – For 7 series

-Rear parking guide line



Factory Default : DISPLAY – ENABLE

①

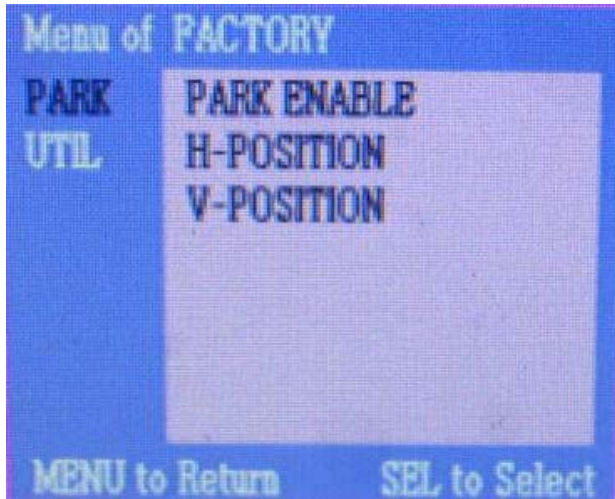

① To get factory mode like left picture, put gear to reverse and press ' $\blacktriangle \rightarrow \blacktriangledown \rightarrow \blacktriangle \rightarrow \text{MENU}$ ' of remote or keypad.

②

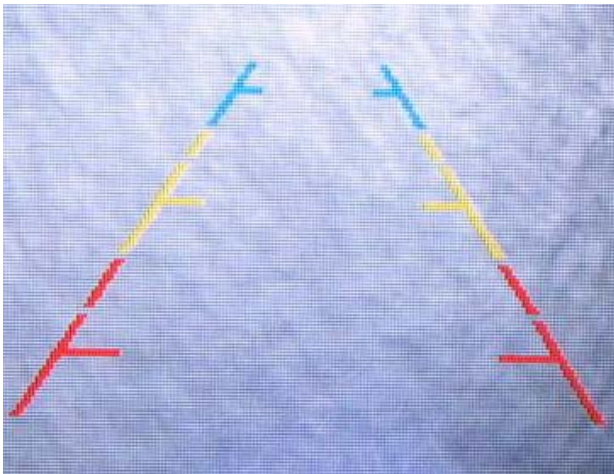

② Select 'PARK ENABLE' to 'ON', then the guide line appears as left picture.

-Rear parking guide line



③

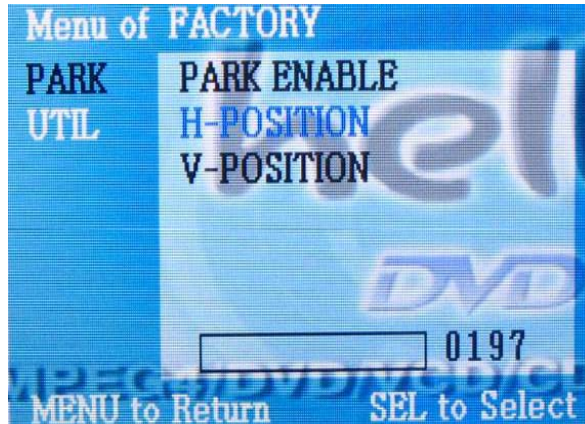

③ On Step no.2, after "Factory Mode" operated, line's position can be moved to left and right in H-POSITION menu.

④

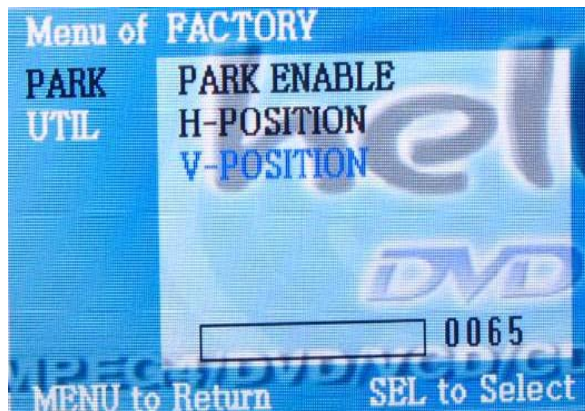

④ Also can move the line to up and down in H-POSITON menu.

-Rear parking guide line (E60)



-Rear Display Setting : Select one of 4 displayed types as below by button on the steering wheel.

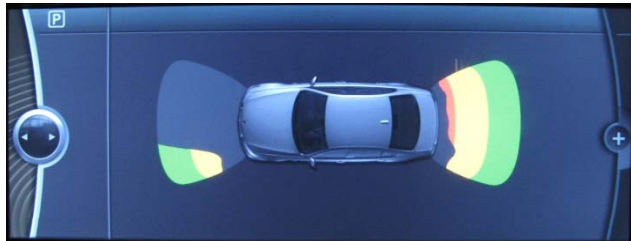

<Full PDC Type>

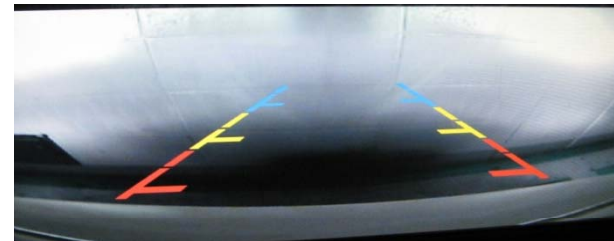

<Full Rear Camera Type>



<Dual Screen type>

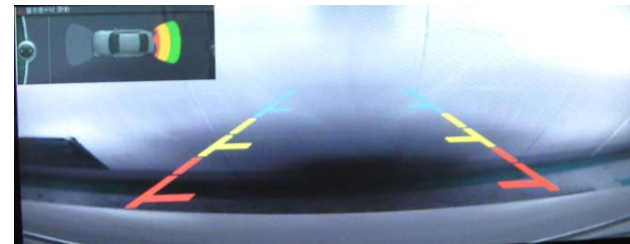

<Full Rear Camera+ Translucent PDC Type>

-Translucent PDC Image positioning : By button on the steering wheel, you can position PDC image to one type of below 3 types.

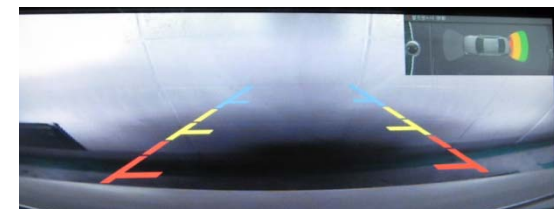
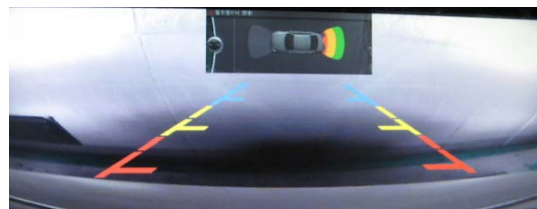

-Rear parking guide line (F01, 02)



-Rear Display Setting : Select one of 4 displayed types as below by  button with long press on I-Drive

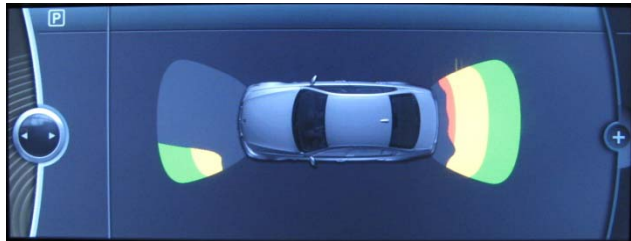

<Full PDC Type>

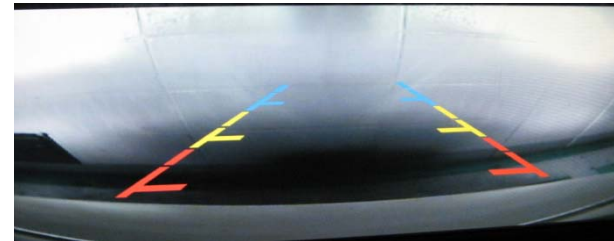

<Full Rear Camera Type>



<Dual Screen type>

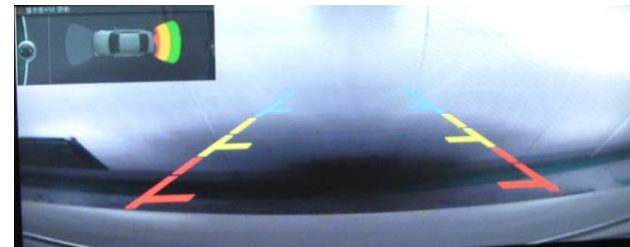

<Full Rear Camera+ Translucent PDC Type>

-Translucent PDC Image positioning : By  button with long press on I-Drive, you can position PDC image to one type of below 3 types.

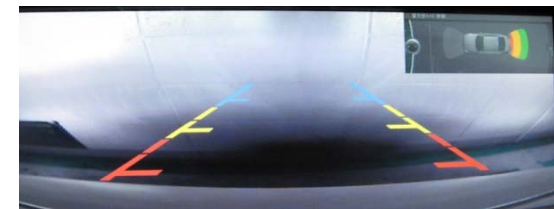

* This function is only available in vehicle with **aftermarket** rear camera

-Product Composition



OSD Keypad or Remote : 1 EA (Optional)
LCD Cable : 1 EA
Navi Cable : 1 EA
Toggle Switch : 1 EA (Optional)

Power Cable : 1 EA
A/V Cable : 1 EA
Ground or IR Cable : 1 EA

-Installation Diagram

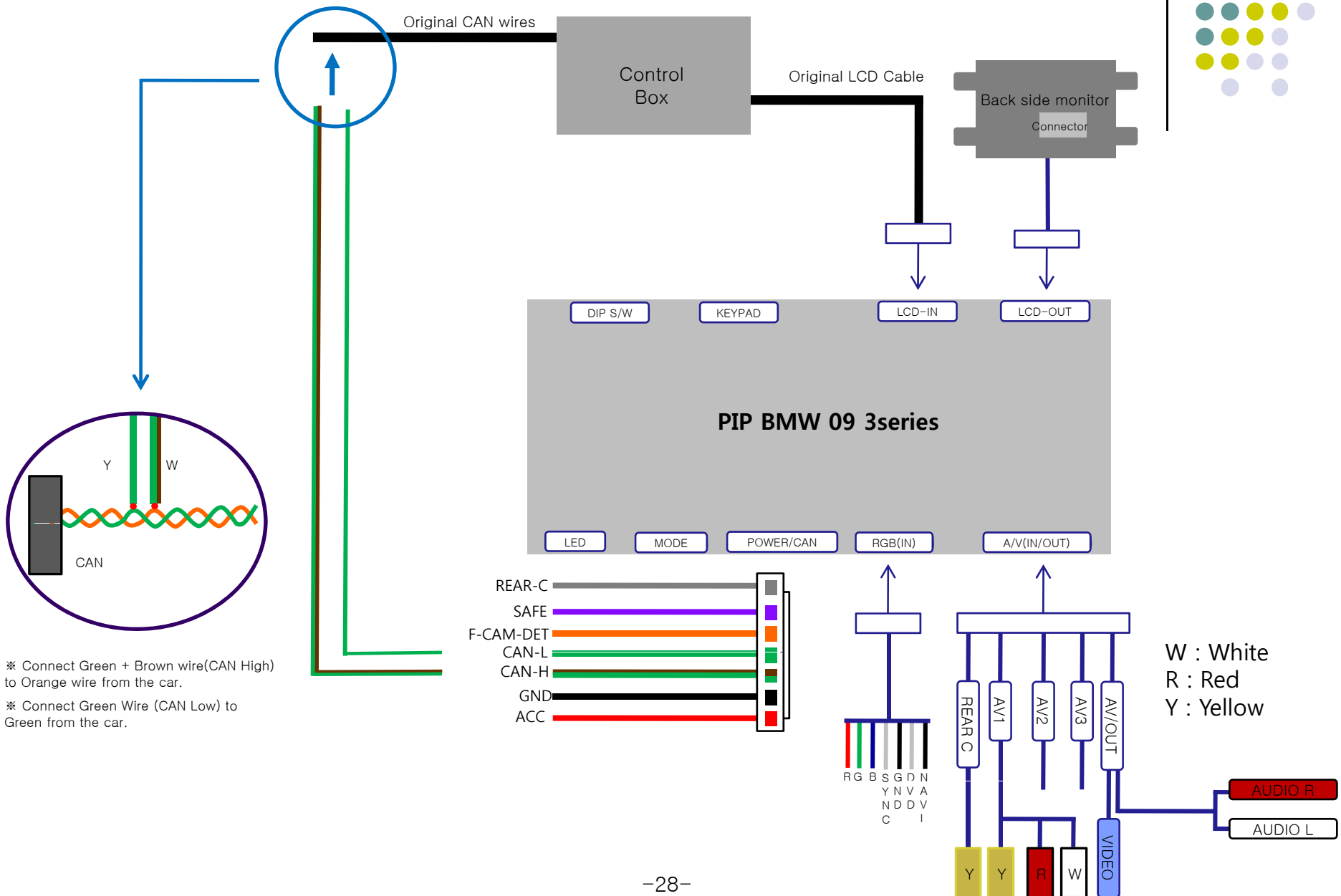

※ Connect Green + Brown wire(CAN High) to Orange wire from the car.

※ Connect Green Wire (CAN Low) to Green from the car.

-Installation Manual



1. Monitor separation



- Remove indicated screws with a proper tool to take apart monitor from the vehicle.



- Pull the monitor out from up to down and take apart it.

-Installation Manual



2. Connecting Monitor with Interface

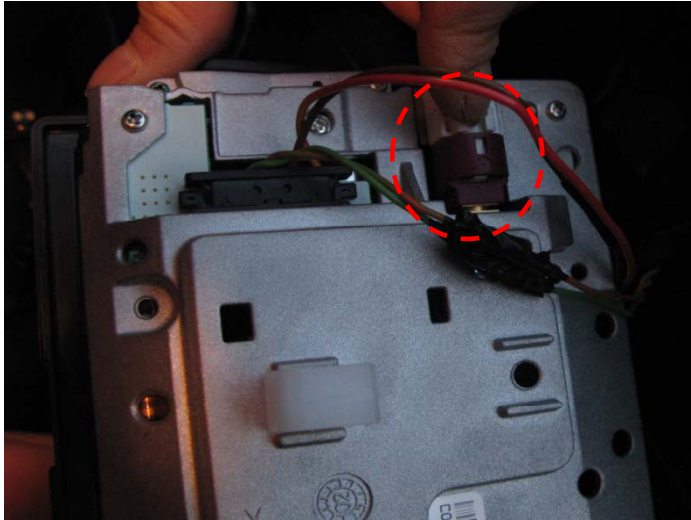

- As left picture, after unplugging the original LCD cable, plug the supplied LCD cable to the indicated connector in the monitor.

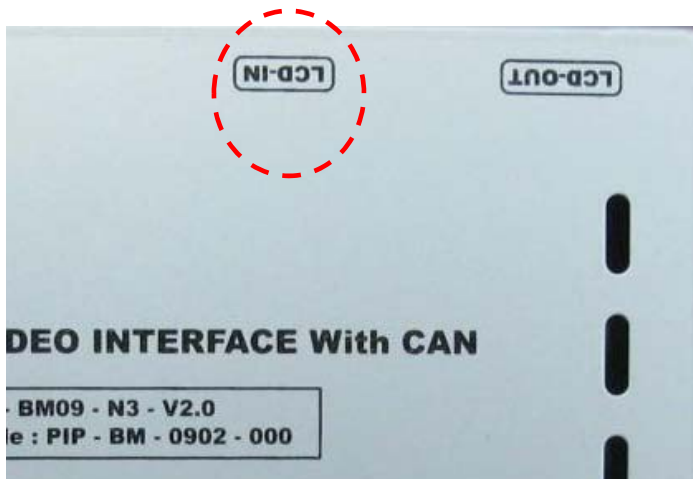

-Connect the unplugged original LCD cable to the interface. Make sure all connections are made correctly the right way as described.

-Installation Manual

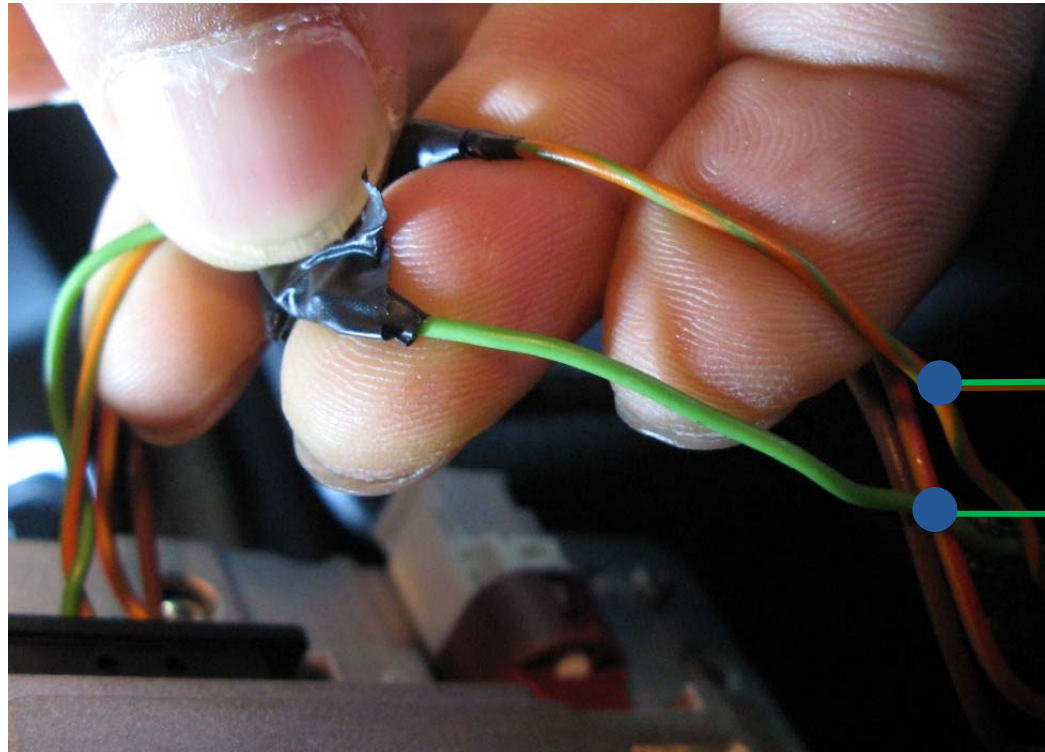

CAN-High

CAN-Low

PIP BMW 09

As the above picture, the offered CAN High wire (Green+Brown) to OEM CAN high (Green+Orange) wire from car, the offered CAN Low wire (Green) to OEM CAN Low (Green)

-Installation Q & A



①



Q. All I got on the screen is black.

**A. Check second LED lamp of the interface is on, if not, check A/V sources connected are working well. (Second lamp indicates AV sources connected works well.)
Check interface connection has been done well.**

②



Q. Screen only displays white like left picture.

A. Check LCD out cable is connected well, if this status keeps, inform to manufacturer.

③

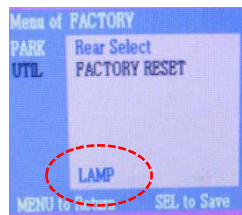

Q. Rear CAM does not appear, when car is in reverse after CAN wiring.

A. Operate "FACTORY MODE" like left picture, then select "UTIL → Rear Select"
If it is set as "LAMP", change it to "CAN" by remote or keypad.

※ LAMP : In case of connecting "Rear-C" wire of Power Cable to Rear Lamp in vehicle.

CAN : In case of detecting Rear Cam thru CAN signal. (CAN must be wired)

④

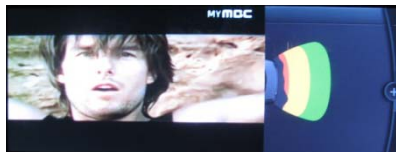

Q. After moving gear to "P" or "D" from "Reverse", I can't get navigation, but half PDC Image in the screen.

- Once, you starts driving, the screen displays navigation right away, this is not an system error.

⑤



Q. After setting PIP function, I got only half OEM image at the right in the screen.

- This is not an error, just caused by user's setting mistake, user should set to "Split Screen" in the OEM menu.

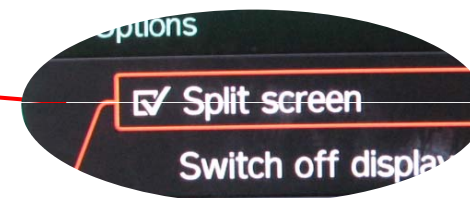

-Installation Q & A



- ⑥ Q. I can not switch A/V sources
A. Check IR or Ground cable connection.
Check LED lamps in the interface, if it is not on, check power cable.
- ⑦ Q. Displayed image color is not proper (too dim or not suitable color)
A. Try to select "INITIAL" in OSD menu, if it does not work, inform to manufacturer.)
- ⑧ Q. Unwanted A/V mode is displayed. (A/V source switching order : OEM->RGB->AV1->AV2->AV3)
A. Check DIP Switch Setting.
- ⑨ Q. OEM image is not displayed.
A. Check interface's LCD In/Out cable connection. If the status keeps on, inform to manufacturer.