

4H7 <7I <EBHA 7 '4' "4("4) "4+"D("D*

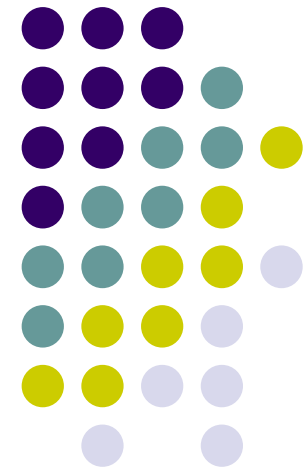

-Precaution



- You must keep the car key taken off from the car while you work this and finally, connect power of the interface.
- When to connect the interface cable, you must keep the power cable taken off.
- You must work this at the environment without any static electricity or damages.
- All of process on this installation should be done by professionals.
- You must not break the labels attached on the board, if it's broken, no warranty.
- When you receive this package you have to check whether there's any parts not included and you have to contact us right away.
- Our repair service do not accept any problems caused by user's any fault or carelessness.

-External Appearance

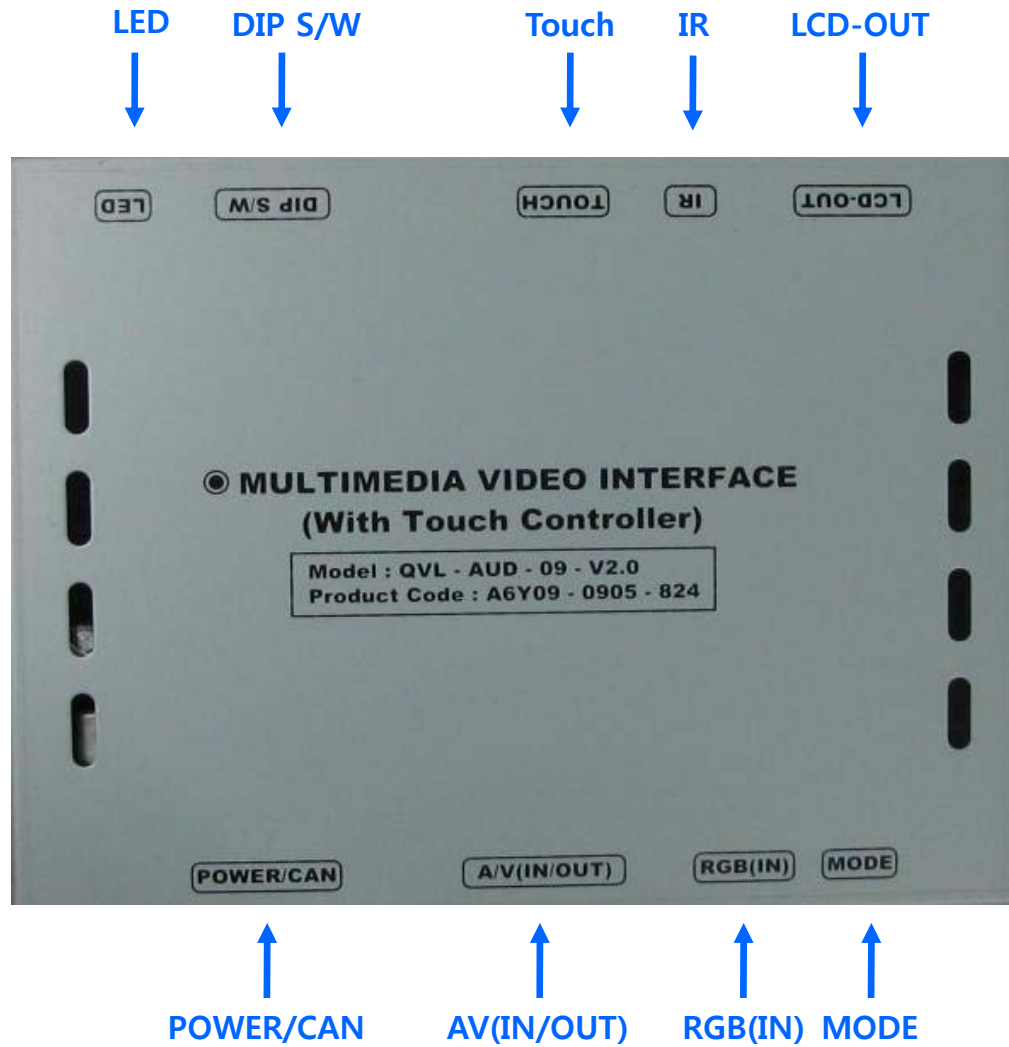

-External Appearance



↑
POWER

↑
A/V(IN/OUT)

↑
RGB(IN)

↑
MODE



↑
LCD-OUT

↑
IR

↑
TOUCH

↑
DIP S/W

↑
LED

Connector Pin Assignment

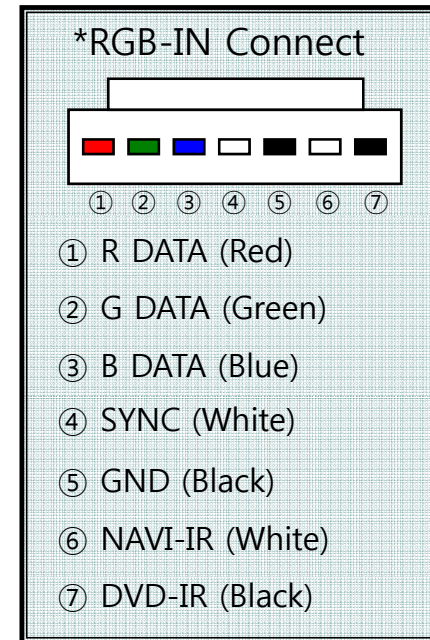
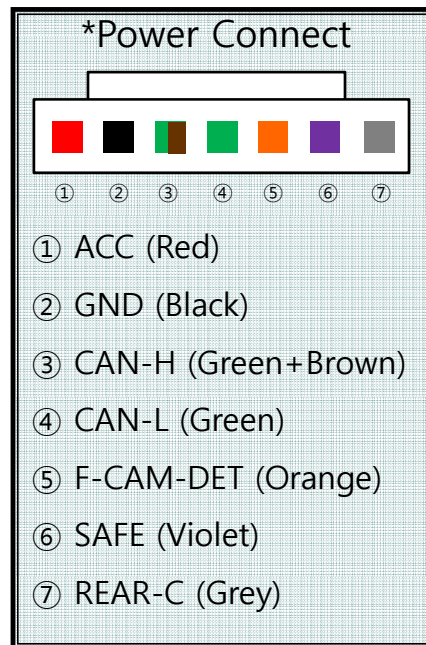

Connector Pin Assignment



* Power Cable

**FILTER
& FUSE BOX**

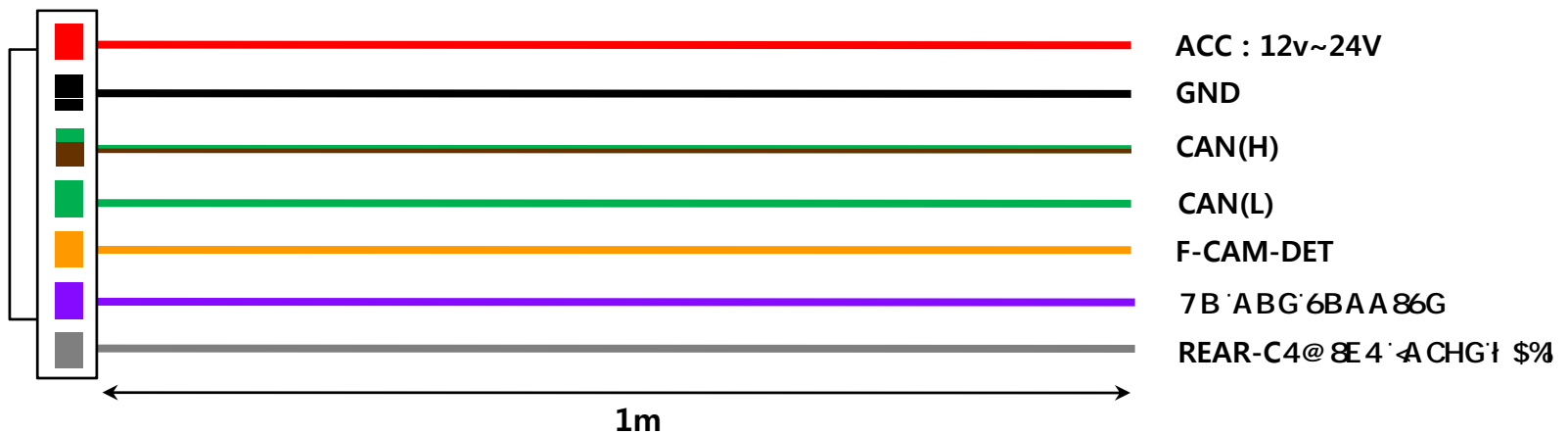
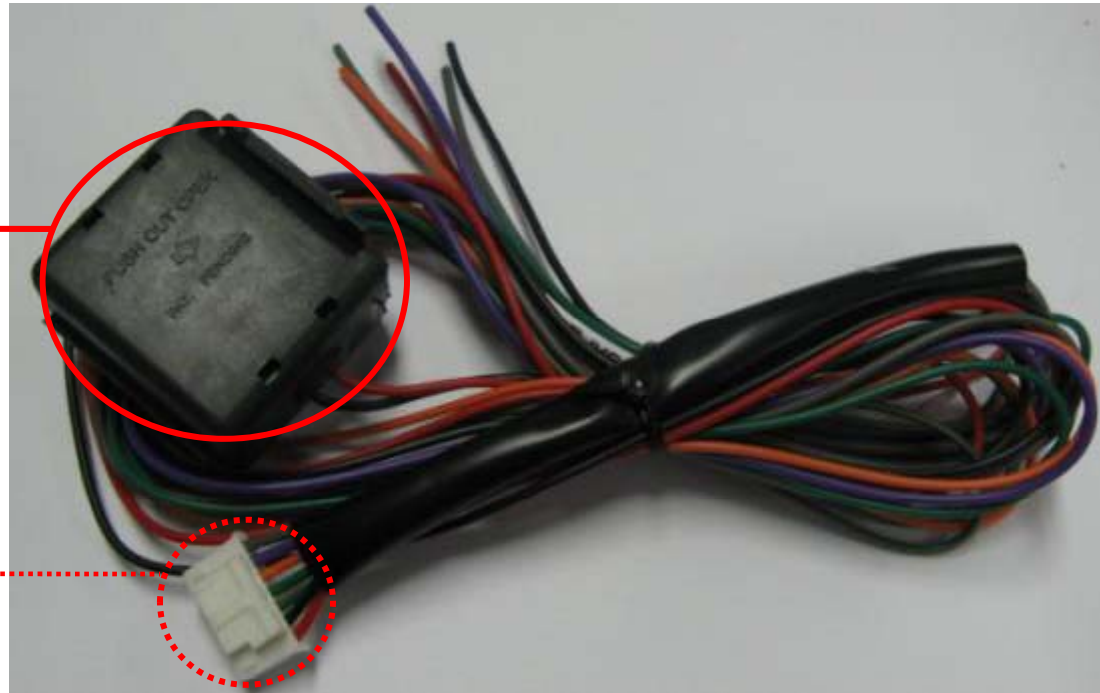

-DIP SW



#PIN	FUNCTION	DIP S/W Selection
1	RGB INPUT MUTE	ON : Skipping RGB Mode OFF : RGB Display
2	A/V 1 MUTE	ON : Skipping A/V 1 OFF : A/V1 Display
3	A/V 2 MUTE	ON : Skipping A/V 2 OFF : A/V2 Display
4	A/V 3 MUTE	ON : Skipping A/V 3 OFF : A/V3 Display
5	LCD TYPE	ON : 7inch LCD with 800*480 Resolution OFF : 6.5inch LCD with 400*240 Resolution
6	N.C	
7	Rear Mode	ON : External Rear Camera OFF : OEM Rear Camera

※DIP S/W Use Example

[AUDI 2009]

- Use Input Mode : A/V3(DVD),
Navigation (RGB)
- Rear Camera : When to be installed
on CVBS 4
- When original Navi is not installed

- ▷ DIP S/W : 1 → OFF
- ▷ DIP S/W : 2,3 → ON
(INPUT MODE SKIP)
- ▷ DIP S/W : 4 → OFF (enable A/V3)
- ▷ DIP S/W : 5 → OFF (ON)
- ▷ DIP S/W : 6 → OFF (ON)
- ▷ DIP S/W : 7 → ON (enable CVBS4)

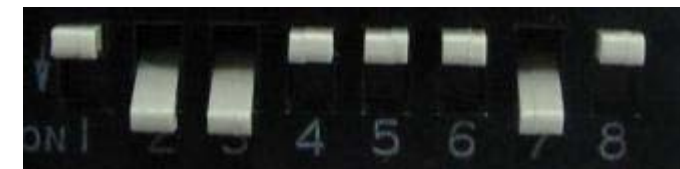

※ ON : DOWN, OFF : UP

-REMOTE CONTROL



POWER & PIP: N.C

MENU : OSD operation

OK : Select

▲ : Up

▼ : Down

◀ : Left, Long press - Factory Mode operation

▶ : Right

***FACTORY MODE (Interface setting)**

**: Operated by long press with ◀ button or
Pressing UP→DOWN→UP→MENU in order**

-OSD(On Screen Display)



※OSD Menu : Operated by "MENU" button of remote.

• Analog RGB Mode



• Video Mode



IMAGE Menu

- BRIGHTNESS
- CONTRAST
- SATURATION
- HUE
- SHARPNESS
- USER IMAGE

OSD(On Screen Display)



• Analog RGB Mode

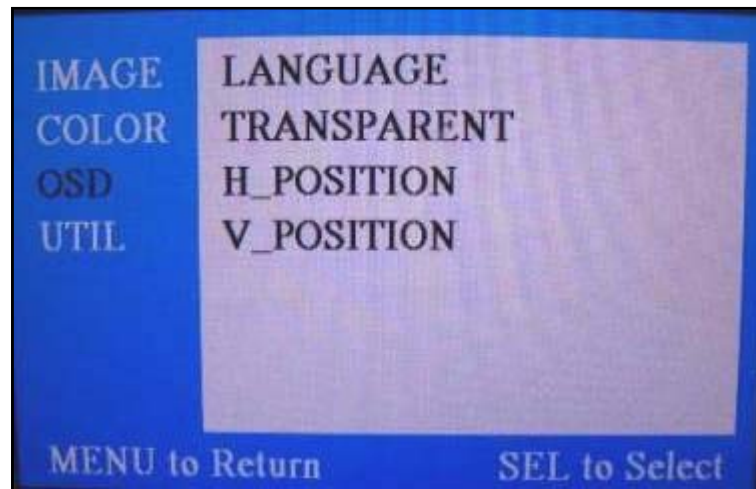

• Video Mode

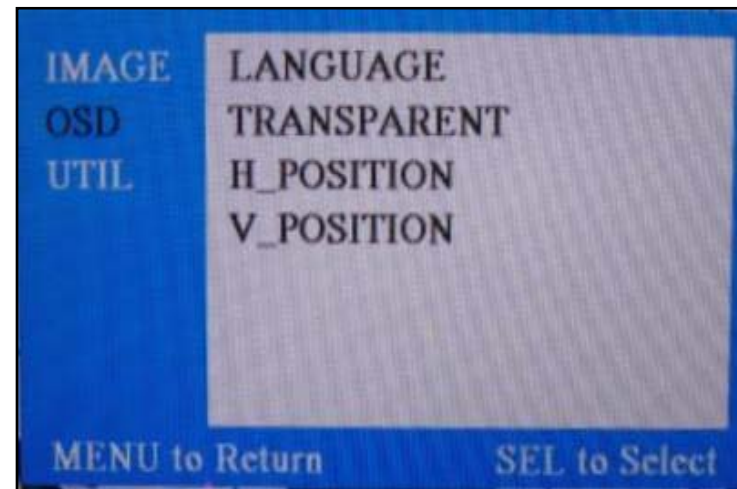

OSD Menu

- LANGUAGE : Language Select of DVD, DMB OSD (ENGLISH, Chinese)
- TRANSPARENT
- H_POSITION
- V_POSITION

OSD(On Screen Display)



- Analog RGB Mode

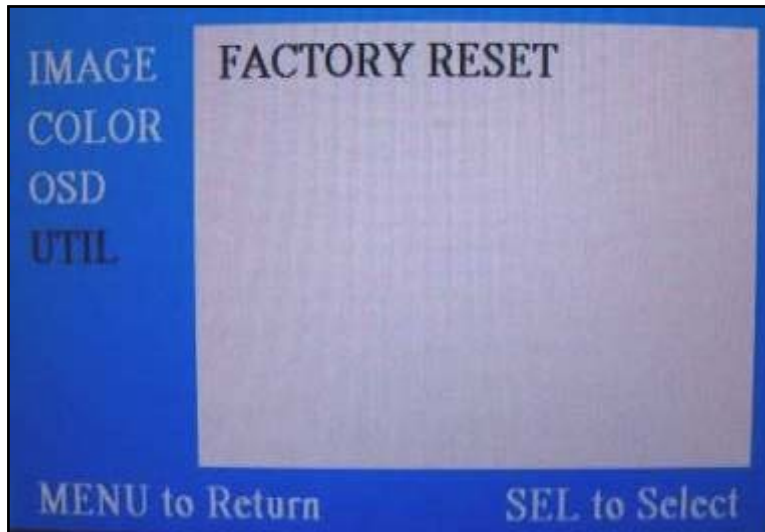

- Video Mode

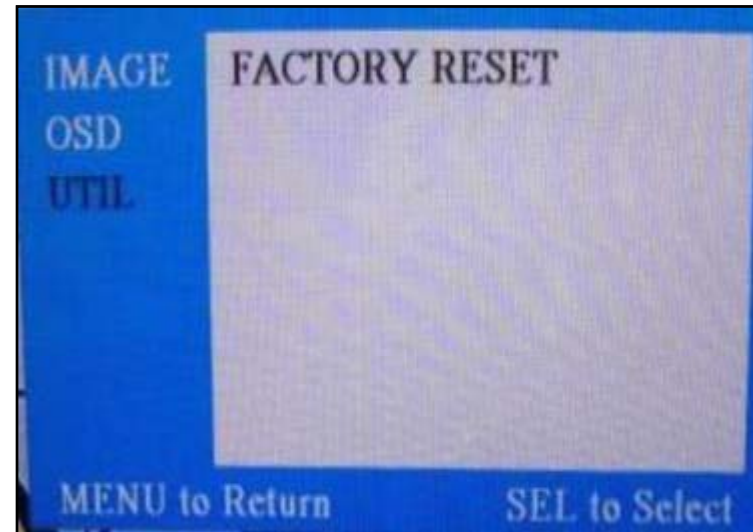

UTIL Menu

- FACTORY RESET : Initializing all set values of navi or DVD

-Factory Mode



- **Factory Mode**-Operated by long press with ◀ button or Pressing UP→DOWN→UP→MENU in order

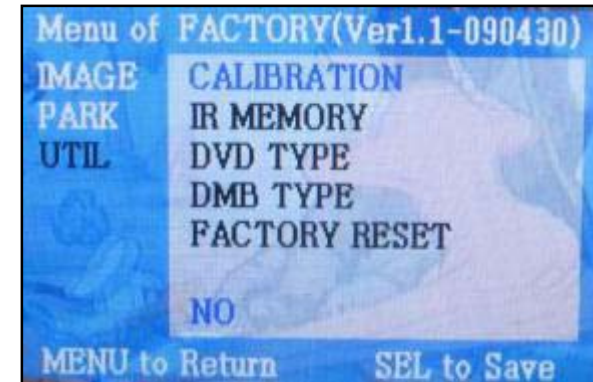
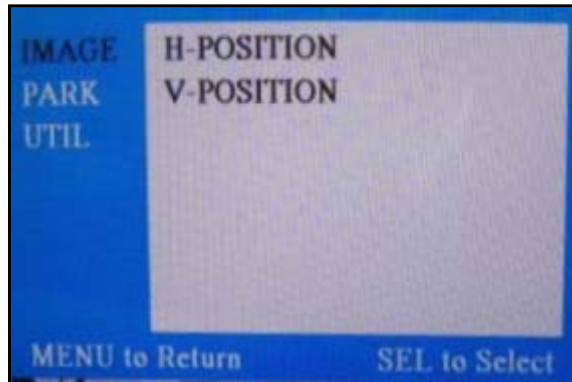

Factory Mode

- **IMAGE** – H-POSITION : Horizontal Image position adjustment
 - V-POSITION : Vertical Image position adjustment
- **PARK** - PARK ENABLE : Rear parking Guide line setting
 - PARK SETUP : Rear parking guide line position adjustment (Refer to page no. 22)
- **UTIL** – CALIBRATION : Touch Calibration (Refer to page no.23)
 - IR MEMORY : Remote button value Memorizing (Refer to page no. 24)
 - DVD TYPE : DVD type setting (Refer to page no. 25)
 - DMB TYPE : DMB type setting (Refer to page no. 25)
 - FACTORY RESET : Initializing

-Factory Mode : Rear parking guide line



Factory Default : PARK ENABLE – OFF



① As left picture, Set "Park Enable" to "ON" in Factory Mode. (Default – OFF)



② After the setting done, rear parking guide line will appear in rear gear position. Once press "OK" button, "H_POS" appears at the right and can adjust the line's position.

Factory Mode : Rear parking guide line



③



③ After H_POS, when pressing "OK" button again, V_POS appears.

※ **FACTORY MODE** : Operated by long press with ◀ button or Pressing UP→DOWN→UP→MENU in order

-Product Composition



Remote : 1 Ea

Power Cable : 1 Ea

LCD Out Cable : 1 Ea

A/V Cable : 1 Ea

Navi Cable : 1 Ea

IR Cable : 1 Ea

Toggle Switch : 1 Ea

LCD Cable : 1 Ea



TOUCH Cable for Board : 1 Ea

TOUCH Screen Cable : 1 Ea

-Installation Structure

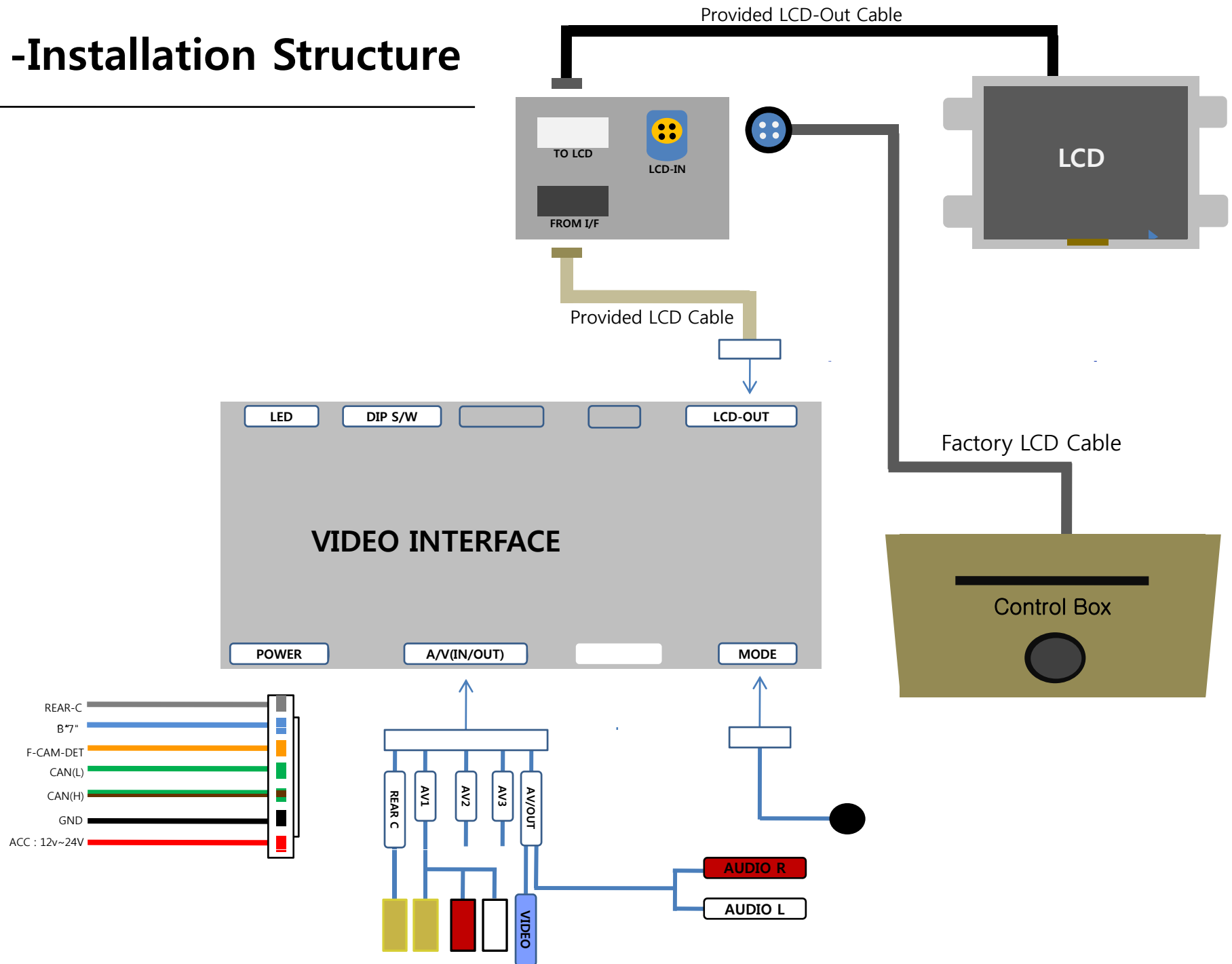

-Installation Guide



1. Connect LCD-OUT, OEM LCD Cables after disassembling LCD



Take apart LCD monitor and factory LCD cable from LCD monitor.

As left picture, after disassembling factory LCD cable, connect provided LCD-OUT cable to the connector.

Connect the opposite side connector to sub-board ("TO MONITOR")

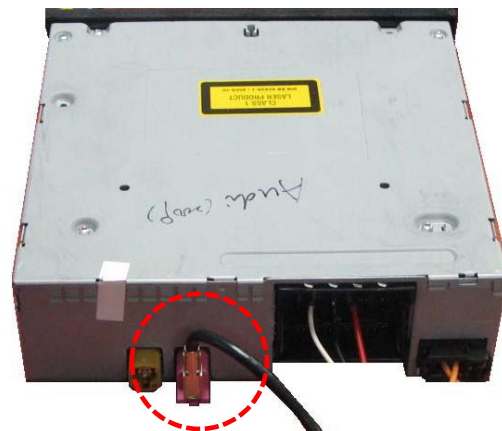

Connect Factory LCD cable from DVD Unit to sub-board ("LCD IN")

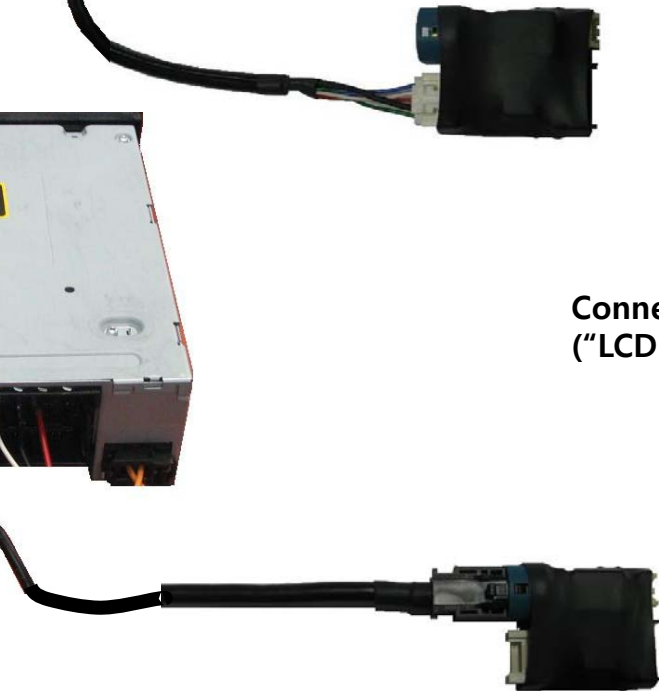

- How to use NAVI button

※ To use Navi button for switching AV source, need to hook MMI wire from Power cable with white wire from original DVD box as below picture.



-FAQ



1. When can not change mode.
 - Check if the IR Cable (Remote) is connected or not.
 - Check if LED is turned on or not. If it is not turned on, Check if power cable is connected or not.
 - Check if CAN is connected well.
2. When the screen is displaying only black color.
 - Check if 2nd LED is turned on or not. If it is not turned on, please check all video sources that you will connect with the interface is operating well or not.
 - Check if interface is connected well.
3. When displayed color of screen is not proper. (If it's too dark or the color is not proper)
 - Try to push "Reset button" on the remote control. If the color of screen keeps on displaying wrong color, you have to ask manufacturer for the problem.
 - Try to adjust Color, Contrast, Brightness by the remote.
4. When Back-up camera is not displayed on the screen.
 - Turn Dip S/W no.7 on.
5. When the mode you set is not skip.
 - Check if Dip S/W is set in proper way.
6. When Main screen on the car is not displayed.
 - Check if In/Out cables are connected well. If it keeps showing the same problem, you have to ask manufacturer for the problem.
7. When the screen is displaying only white color.
 - Check if out cable is connected well. If it keeps showing the same problem, you have to ask manufacturer for the problem.